

Article number: 20285B12B122SW

Description: E+G Swivel clamp connector joint
GN285-B12-B12-2-SW

Measures

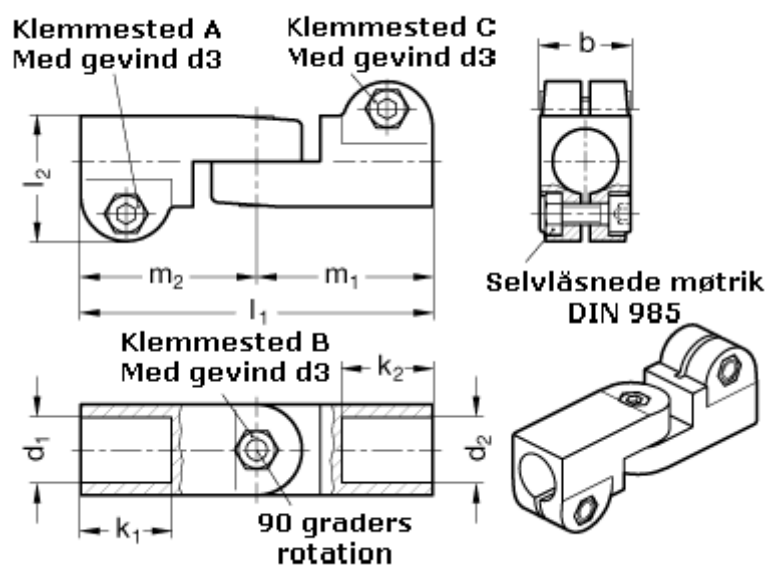

b = 25	m1 = 48.5
d1 = B12	m2 = 48.5
d2 = B12	
d3 = M 6	
k1 = 25	
k2 = 25	
l1 = 97	
l2 = 34.5	